



Sink Faucet Deckmount

8" Deck- CER-TECK® ceramic structures

Model No: 26C3244-S7

COMPLIES WITH:

- CSA certified.
- Complies to ASME A112.18.1/CSA B125.1
- Verified compliant with 0.25% weighted average Pb content regulations
- (Contact Delta Representative for State and/or Local Approvals)



NOTES:

26T3 - 8" Deck- TUF-TECK® compression structures

SPECIFICATION:

- Heavy Duty Cast Brass sink faucet
- 203 mm (8") centers
- Two handle
- Polished chrome plated finish
- Metal hold-down package
- CER-TECK® ceramic structures
- Spout: S7 - 279mm (11") Tubular Swing Spout(S7)
- Outlet#: 4 - Standard 1.5 GPM (5.7 L/Min) Flow Control Aerator
- Handle#: 4 - 102 mm (4") Blade Handles- ADA Compliant-Sanitary Hoods- Metal-Color indexed-Vandal resistant screws

OPERATION:

- Not Available

(Dimensional drawing on following page)

Delta reserves the right (1) to make changes to specifications and materials, and (2) to change or discontinue models, both without notice or obligation. Dimensions are for reference. Measurement may vary plus or minus 6mm(0.25"). Mounting locations are suggested only. Check with local codes for requirements in your area. This spec was produced April 14, 2021.

Delta Faucet Company - 55 East 111th St. - Indianapolis, Indiana, USA 46280 - (317) 848-1812
Delta Faucet Canada - 395 Matheson Blvd E - Mississauga, Ontario, Canada L4Z 2H2 - (905) 712-3030

Model No: 26C3244-S7

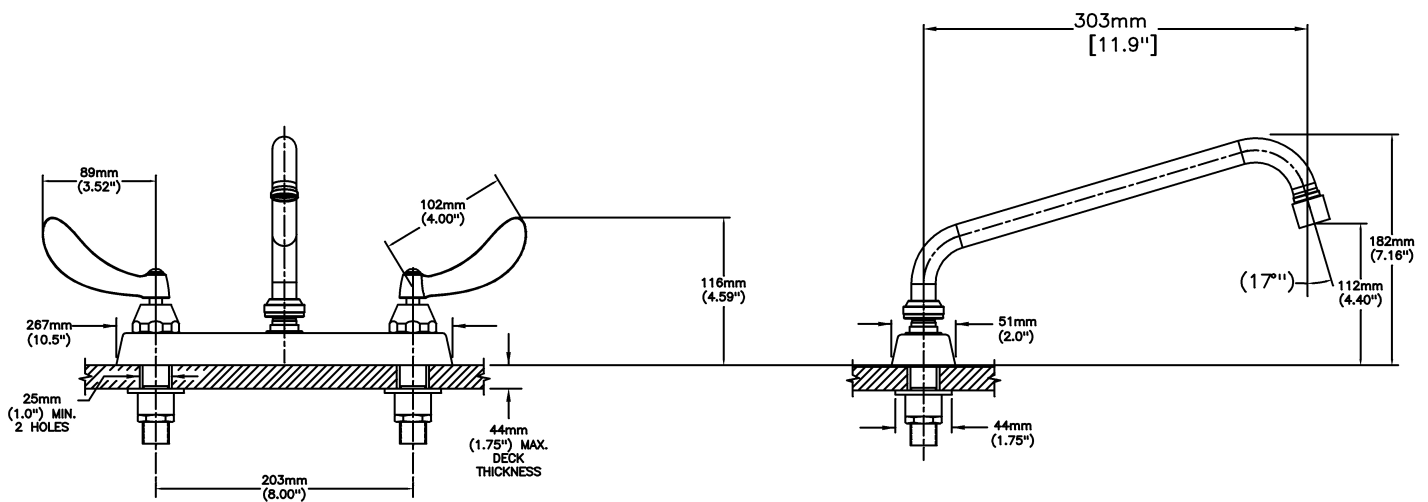

INLET FOR 3/8" OR 1/2" FLEXIBLE RISER
OR 1/2-14 NPSM COUPLING NUT (NOT SUPPLIED)

Delta reserves the right (1) to make changes to specifications and materials, and (2) to change or discontinue models, both without notice or obligation. Dimensions are for reference. Measurement may vary plus or minus 6mm(0.25"). Mounting locations are suggested only. Check with local codes for requirements in your area. This spec was produced April 14, 2021.

Delta Faucet Company - 55 East 111th St. - Indianapolis, Indiana, USA 46280 - (317) 848-1812
Delta Faucet Canada - 395 Matheson Blvd E - Mississauga, Ontario, Canada L4Z 2H2 - (905) 712-3030